

Aneto DALI

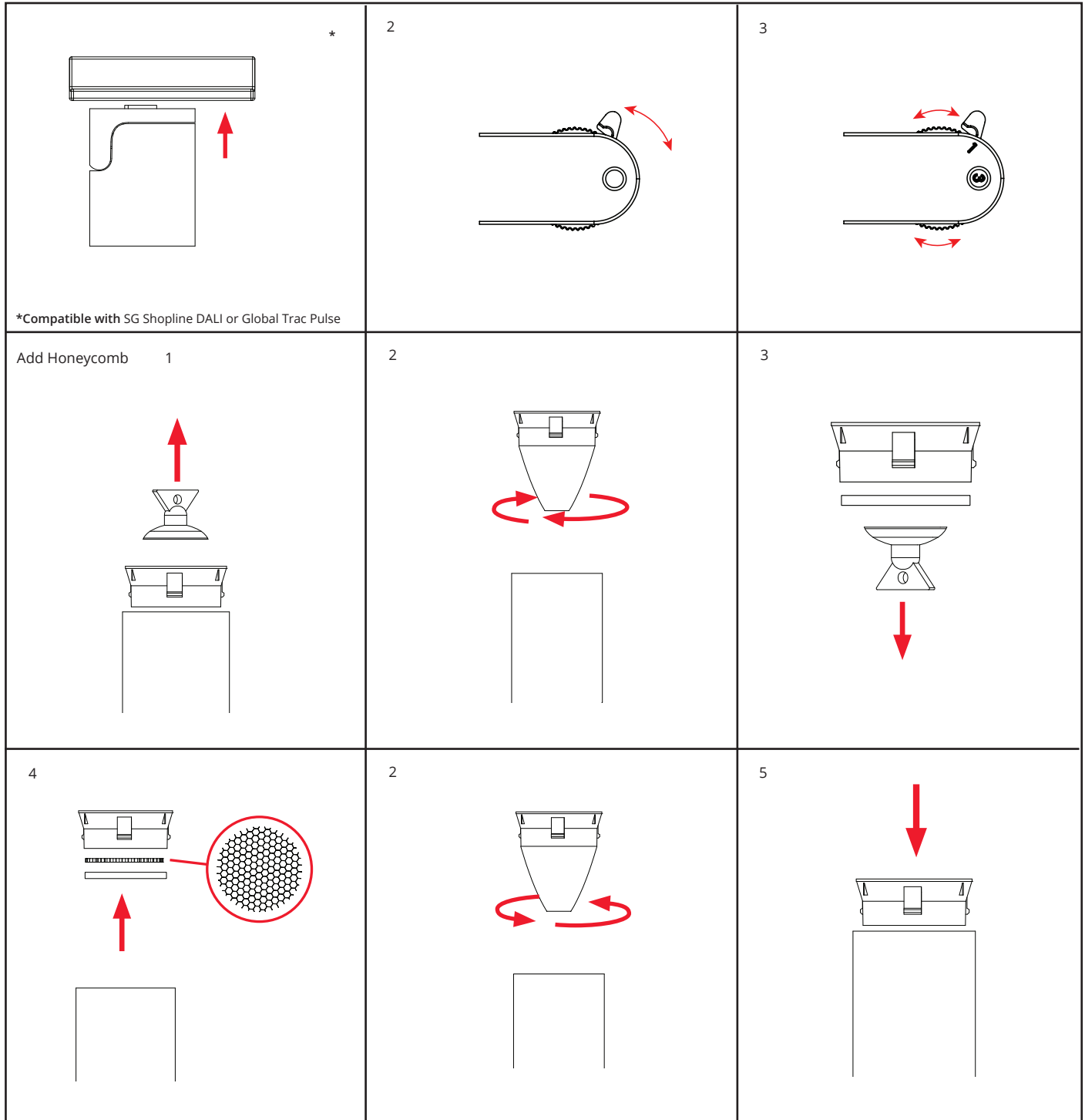

220-240V, 50/60Hz



NORWAY
SG Armaturen AS

Skytterheia 25
N-4790 Lillesand

Tel: +47 37 50 03 00
firmapost@sg-as.no
www.sg-as.no

SWEDEN

SG Armaturen AB
Tel: +46 31 81 71 10
info@sg-ab.se
www.sg-ab.se

FINLAND

SG Armaturen Oy
Tel: +358 02 07 30 39 60
info@sg-oy.fi
www.sg-oy.fi

DENMARK

SG Armaturen A/S
Tel: +45 70 70 72 13
info@sg-as.dk
www.sg-as.dk

UNITED KINGDOM

SG Lighting LTD
Tel: +47 37 50 03 00
info@sglighting.co.uk
www.sglighting.co.uk

FRANCE

SG Lighting SA/NV
Tel: +33(0) 4 94 93 00 00
info.france@sglighting.fr
www.sglighting.net

BENELUX

SG Lighting SA/NV
Tel: +32(0) 15 20 72 71
info.benelux@sglighting.net
www.sglighting.net

GERMANY

SG Leuchten GmbH
Tel: +49 40 23 99 44 59
info@sg-leuchten.de
www.sg-leuchten.de

INTERNATIONAL

SG Lighting Co Ltd.
Tel: +86 769 88 49 20 88
cindy@sgdgc.com
www.sg-as.com

Reflector Change

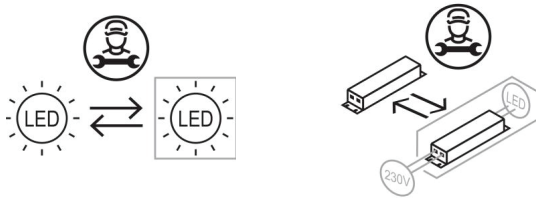
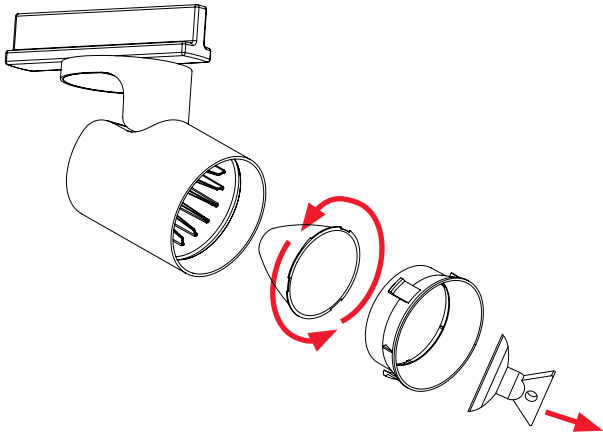

NO: Det er brukerens ansvar å sørge for elektrisk, mekanisk og termisk kompatibilitet mellom skinner-systemet og tilkoblede armaturer.
DK: Det er brugerens ansvar at sikre elektrisk, mekanisk og termisk kompatibilitet mellem skinner-systemet og tilsluttede armaturer.
SE: Det är användarens ansvar att säkerställa elektrisk, mekanisk och termisk kompatibilitet mellan räls-systemet och anslutna armaturer.
EN: It is the user's responsibility to ensure electrical, mechanical and thermal compatibility between the track system and luminaires attached to it.
FR: L'utilisateur doit s'assurer de la compatibilité électrique, thermique et mécanique entre le système Track et les luminaires qui lui sont rattachés.
NL: Het is de verantwoordelijkheid van de gebruiker om na te gaan of the track-systeem en de gebruikte verlichtingstoestellen elektrisch, mechanisch en thermisch compatibel zijn.
DE: Der Anwender/Elektroinstallateur hat sicherzustellen, dass die elektrische, mechanische und thermische Kompatibilität zwischen dem Schienensystem und den Leuchten gegeben ist.
FI: Käyttäjän vastuulla on varmistaa sähköinen, mekaaninen ja terminen yhteensopivuus kosketinkiskon ja siihen liitettyjen valaisimien välillä.

NO: Kan kun installeres og vedlikeholdes av en registrert installasjonsvirksomhet.
DK: Må kun installeres og vedligeholdes af uddannet elektriker.
SE: Skall installeras och underhållas av behörig elektriker.
EN: Only to be installed and maintained by an authorized electrician.
FR: Doit être installé et maintenu par un électricien qualifié.
NL: Mag alleen geïnstalleerd en onderhouden worden door een bevoegde elektricien.
DE: Dieses Produkt darf nur durch autorisiertes Personal (z.B. Elektro-Installateur) angeschlossen, in Betrieb genommen und gewartet werden.
FI: Asentaa ja huoltaa saa vain valtuutettu sähköasentaja

NO: Skru av strømmen før montering.
DK: Sluk for strømmen inden montering.
SE: Stäng av strømmen innan montering.
EN: Turn off power before installing.
FR: Couper le courant avant l'installation.
NL: Stroom uitschakelen voor u het toestel installeert.
DE: Vor Installationsarbeiten den Strom abschalten.
FI: Sammuta virta ennen kytkemistä

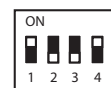
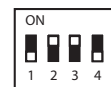
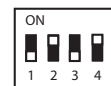
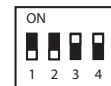
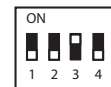
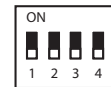
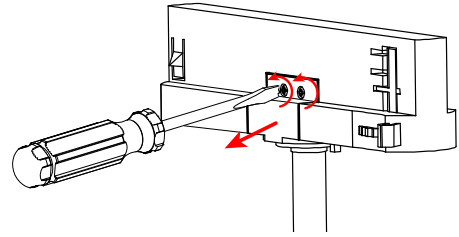

Standard



	mA	lm
	300	37%
	350	43%
	400	50%
	450	56%
	500	62%
	550	68%
	600	75%
	650	81%
	700	85%
	750	93%
	800	100%
	850	-
	900	-
	950	-
	1000	-
	1050	-